

INSTRUCTIONS FOR INSTALLATION,  
USE AND MAINTENANCE

# FUGA eL





General instructions and regulations	
Maintenance .....	5
Service .....	5
Declaration .....	5
Characteristics report .....	5
Description of the Fuga eL .....	5
HETAS supplement	
Health and Safety precautions .....	6
Chimney .....	7
Hearth .....	8
Combustion air supply .....	8
Connection to chimney .....	8
Commissioning and handover .....	8
Manual	
What you should know about the Fuga eL .....	9
The three basic rules for proper burning .....	9
Warning note .....	10
Important notes .....	10
User operating instructions .....	11
The fine heat from wood .....	12
Initial fire-up, a good start .....	12
Initial fire-up in steps .....	13
How to use the Fuga eL .....	14
The power of fire .....	15
A few tips .....	15
Maintenance	
Ceramic firebricks .....	16
Glass .....	16
Moving parts .....	16
Collecting soot when sweeping the chimney .....	17
Installation instructions	
Fuga eL specifications .....	18
General instructions and regulations .....	19
Safety recommendations .....	19
Materials and tools required .....	19
Installation diagrams .....	20 / 21

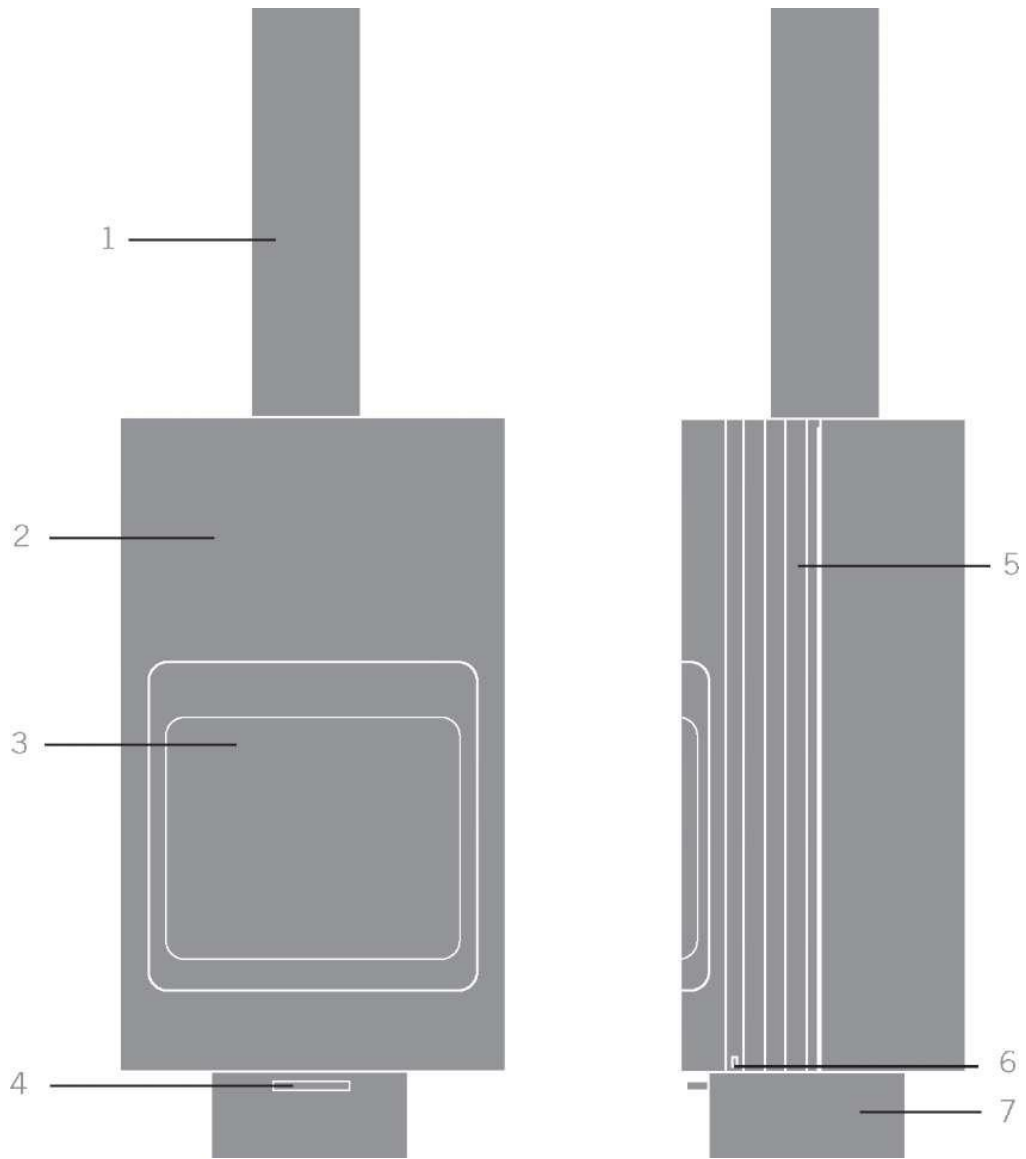

1. **Flue**
2. **Case**
3. **Ceramic glass**
4. **Aeration slide**
5. **Convection fins**
6. **Door handle**
7. **Base**

## General instructions and regulations

### Maintenance

Have the appliance serviced regularly by a qualified technician.  
Ensure that the flue-gas connection and the chimney are cleaned regularly.  
Check to ensure that the chimney is still open before lighting the stove again if it has not been used for an extended period of time.  
If, in spite of the precautions taken, there should occur a chimney fire (usually accompanied by a roaring noise in the chimney), proceed as follows:  
Shut off the air supply and close the door of the stove immediately  
Call the fire brigade  
Quickly extinguish the fire in the stove with sand to prevent smoke from getting into your house  
Ventilate the house  
Never use water to extinguish the fire  
Ensure that after a fire the chimney is first swept and inspected for any damage and leaks.

### Service

It is not allowed to make any modifications to the appliance without prior authorization of the manufacturer.  
Only use replacement parts recommended by the manufacturer.

### Declaration

The undersigned, representing the following:  
Harrie Leenders Haardkachels, Industrieweg 25, 5688 DP, Oirschot, Nederland  
herewith declare that the product Fuga eL is in conformity with the provisions of the following EC Directives when installed in accordance with the installation instructions contained in the product documentation: EN 13240:2001/A2:2004 (E) "Roomheaters fired by solid fuel"  
Product: Roomheaters fired by solid fuels as covered under the scope of this standard intended use: Space heating in residential buildings.

### Characteristics Report

Fire safety	2005PMC/12
Emission of combustion products	2005PMC/12
Release of dangerous substance	2005PMC/12
Surface temperature	2005PMC/12
Mechanical resistance (to carry a chimney / flue)	2005PMC/12
Thermal output / energy efficiency	2005PMC/12

### Description of the room heater Fuga eL:

Wood stove made of sheet metal. The stove is designed to be installed on the wall. It is provided with a self-closing window door, fixed secondary air supply and controllable air wash air supply. The combustion chamber is insulated with refractory ceramic elements. The flue-gas connection is located at the top of the appliance.

Notified body: SGS Environmental Services, Postbus 5252, 6802 EG Amhem  
Report number: 2005PMC/12  
Manufacturer: Harrie Leenders Haardkachels



Name: Bart Leenders  
Position: General Manager  
Date: 15-07-2005

## **READ THE INSTRUCTION BOOKLET AND THESE SUPPLEMENTARY INSTRUCTIONS CAREFULLY BEFORE INSTALLATION**

These instructions together with those in the instruction booklet cover the basic principles to ensure the satisfactory installation of the stove, although detail may need slight modification to suit particular local site conditions.

In all cases the installation must comply with current Building Regulations, Local Authority Byelaws and other specifications or regulations as they affect the installation of the stove. It should be noted that the Building Regulations requirements may be met by adopting the relevant recommendations given in British Standards BS 8303, BS EN 15287-1:2007 as an alternative means to achieve an equivalent level of performance to that obtained following the guidance given in Approved Document J.

Please note that it is a legal requirement under England and Wales Building Regulations that the installation of the stove is either carried out under Local Authority Building Control approval or is installed by a Competent Person registered with a Government approved Competent Persons Scheme. HETAS Ltd operate such a Scheme and a listing of their Registered Competent Persons can be found on their website at [www.hetas.co.uk](http://www.hetas.co.uk).

### **CO Alarms:-**

Building regulations require that when ever a new or replacement fixed solid fuel or wood/ biomass appliance is installed in a dwelling a carbon monoxide alarm must be fitted in the same room as the appliance. Further guidance on the installation of the carbon monoxide alarm is available in BS EN 50292:2002 and from the alarm manufacturer's instructions.

**Provision of an alarm must not be considered a substitute for either installing the appliance correctly or ensuring regular servicing and maintenance of the appliance and chimney system.**

## **HEALTH AND SAFETY PRECAUTIONS**

Special care must be taken when installing the stove such that the requirements of the Health and Safety at Work Act are met.

### **Handling**

Adequate facilities must be available for loading, unloading and site handling.

### **Fire Cement**

Some types of fire cement are caustic and should not be allowed to come into contact with the skin. In case of contact wash immediately with plenty of water.

### **Asbestos**

This stove contains no asbestos. If there is a possibility of disturbing any asbestos in the course of installation then please seek specialist guidance and use appropriate protective equipment.

### **Metal Parts**

When installing or servicing this stove care should be taken to avoid the possibility of personal injury.

## **STOVE PERFORMANCE**

Please refer to the table in the main instruction manual for details of the stoves' performances

## PREPARATORY WORK AND SAFETY CHECKS

### IMPORTANT WARNING

This stove must not be installed into a chimney that serves any other heating appliance.

There must not be an extractor fan fitted in the same room as the stove as this can cause the stove to emit fumes into the room.

### Chimney

In order for the stove to perform satisfactorily the chimney height must be sufficient to ensure an adequate draught of approximately 15 Pa so as to clear the products of combustion and prevent smoke problems into the room.

NOTE: A chimney height of not less than 4.5 metres measured vertically from the outlet of the stove to the top of the chimney should be satisfactory. Alternatively the calculation procedure given in EN 13384-1 may be used as the basis for deciding whether a particular chimney design will provide sufficient draught.

The outlet from the chimney should be above the roof of the building in accordance with the provisions of Building Regulations Approved Document J.

If installation is into an existing chimney then it must be sound and have no cracks or other faults which might allow fumes into the house. Older properties, especially, may have chimney faults or the cross section may be too large i.e. more than 230 mm x 230 mm. Remedial action should be taken, if required, seeking expert advice, if necessary. If it is found necessary to line the chimney then a flue liner suitable for solid fuel must be used in accordance with Building Regulations Approved Document J.

Any existing chimney must be clear of obstruction and have been swept clean immediately before installation of the stove. If the stove is fitted in place of an open fire then the chimney should be swept one month after installation to clear any soot falls which may have occurred due to the difference in combustion between the stove and the open fire.

If there is no existing chimney then any new system must be to the designation described above and in accordance with Building Regulations Approved Document J.

A single wall metal fluepipe is suitable for connecting the stove to the chimney but is not suitable for use as the complete chimney. The chimney and connecting fluepipe must have a minimum diameter of 150 mm and its dimension should be not less than the size of the outlet socket of the stove.

Any bend in the chimney or connecting fluepipe should not exceed 45°. 90° bends should not be used.

Combustible material should not be located where the heat dissipating through the walls of fireplaces or flues could ignite it. Therefore when installing the stove in the presence of combustible materials due account must be taken of the guidance on the separation of combustible material given in Building Regulations Approved Document J and also in these stove instructions.

If it is found that there is excessive draught in the chimney then a draught stabiliser should be fitted. Fitting of a draught stabiliser will affect the requirement for the permanent air supply into the room in which the stove is fitted in accordance with Approved Document J (see also combustion air supply).

Adequate provision e.g. easily accessible soot door or doors must be provided for sweeping the chimney and connecting fluepipe where it is not intended for the chimney to be swept through the appliance.

### **Hearth**

The hearth should be able to accommodate the weight of the stove and its chimney if the chimney is not independently supported. The weight of the stove is indicated in the brochure.

The stove should preferably be installed on a non-combustible hearth of a size and construction that is in accordance with the provisions of the current Building Regulations Approved Document J.

The clearance distances to combustible material beneath, surrounding or upon the hearth and walls adjacent to the hearth should comply with the guidance on the separation of combustible material given in Building Regulations Approved Document J and also in these stove instructions.

If the stove is to be installed on a combustible floor surface, it must be covered with a non-combustible material at least 12mm thick, in accordance with Building Regulations Approved Document J, to a distance of 30 cm in front of the stove and 15 cm to each side measuring from the door of the combustion chamber.

### **Combustion air supply**

In order for the stove to perform efficiently and safely there must be an adequate air supply into the room in which the stove is installed to provide combustion air. The provision of air supply to the stove must be in accordance with current Building Regulations Approved Document J. An opening window is not appropriate for this purpose.

### **Connection to chimney**

Stoves may have a choice of either a rear or top flue gas connector that allows connection to either a masonry chimney or a prefabricated factory made insulated metal chimney in accordance with their instructions. In some cases it may be necessary to fit an adaptor to increase the diameter of the flue to the minimum required 150 mm section of the chimney or liner.

### **Commissioning and handover**

Ensure all parts are fitted in accordance with the instructions.

On completion of the installation allow a suitable period of time for any fire cement and mortar to dry out, before lighting the stove. Once the stove is under fire check all seals for soundness and check that the flue is functioning correctly and that all products of combustion are vented safely to atmosphere via the chimney terminal.

On completion of the installation and commissioning ensure that the operating instructions for the stove are left with the customer. Ensure to advise the customer on the correct use of the appliance and warn them to use only the recommended fuel for the stove.

Advise the user what to do should smoke or fumes be emitted from the stove. The customer should be warned to use a fireguard to BS 8423:2002 (Replaces BS 6539) in the presence of children, aged and/or infirm persons.

## Manual

We congratulate you on the purchase of your stove. This manual will inform you about the best way of using the stove and the art of keeping a perfect fire. Before using the stove, carefully read the text about breaking in the stove.

These heating instructions apply to the Fuga eL. They are merely intended as a guideline as your stove will behave differently according to the place where it is installed, simply because the conditions are different. The flue, the weather, the quality of the wood used and the climate conditions in the house determine your stove's burning behaviour. In time you will develop your own directions for use, based on these heating instructions.

### What you should know about the Fuga eL

The Fuga eL is a radiant stove with convection which, when the stove is burning properly, ensures a fine heat distribution.

The burning chamber is lined inside with high-grade ceramic firebrick elements (prisolith).

The aeration slide is opened by pulling it outwards (kindling position).

You open the door on the right side of the stove.

### The three basic rules for proper burning are:

1 Use dry and clean wood.

The stove is suitable for burning so-called 'stackable fuels': wood and briquettes. We assume you will be using dry fuels only. So, this also holds for the kindling paper and cardboard. Wet fuel costs more energy, leaves moisture on the glass and soils the flue.

2 Do not temper the burning process excessively.

Allow the stove sufficient time to warm up (stay with it at this stage) and do not temper the fire too quickly. Bear this rule in mind: you must not temper a stove until it has warmed up properly.

3 Always make sure there is enough fresh air.

In houses today, cracks and gaps have often been sealed. Opening a small grate or cantilever window will ensure sufficient fresh air, provided no fresh-air-supply system is used.

The main thing when making the fire is that both the flue and the stove reach the proper temperature.

Each time you want to open the stove when burning, the air-control slide must be open (completely pulled out) to ensure proper air supply.

## **READ THE INSTRUCTION BOOK AND THESE INSTRUCTIONS CAREFULLY BEFORE USING THE STOVE**

### **WARNING NOTE**

Properly installed, operated and maintained this stove will not emit fumes into the dwelling. Occasional fumes from de-ashing and re-fuelling may occur. However, persistent fume emission is potentially dangerous and must not be tolerated. If fume emission does persist, then the following immediate action should be taken: -

- (a) Open doors and windows to ventilate the room and then leave the premises.
- (b) Let the fire go out.
- (c) Check for flue or chimney blockage and clean if required
- (d) Do not attempt to relight the fire until the cause of the fume emission has been identified and corrected. If necessary seek expert advice.

The most common cause of fume emission is flue way or chimney blockage. For your own safety these must be kept clean at all times.

### **IMPORTANT NOTES**

#### **General**

Before lighting the stove check with the installer that the installation work and commissioning checks described above have been carried out correctly and that the chimney has been swept clean, is sound and free from any obstructions. As part of the stoves' commissioning and handover the installer should have shown you how to operate the stove correctly.

#### **CO Alarm**

Your installer should have fitted a CO alarm in the same room as the appliance. If the alarm sounds unexpectedly, follow the instructions given under "Warning Note" above.

#### **Use of fireguard**

When using the stove in situations where children, aged and/or infirm persons are present a fireguard must be used to prevent accidental contact with the stove. The fireguard should be manufactured in accordance with BS 8423:2002 (Replaces BS 6539).

#### **Chimney cleaning**

The chimney should be swept at least twice a year. It is important that the flue connection and chimney are swept prior to lighting up after a prolonged shutdown period.

If the stove is fitted in place of an open fire then the chimney will require sweeping after a month of continuous operation. This is a precaution to ensure that any "softer" deposits left from the open fire usage have not been loosened by the higher flue temperatures generated by the closed stove.

In situations where it is not possible to sweep through the stove the installer will have provided alternative means, such as a soot door. After sweeping the chimney the stove flue outlet and the flue pipe connecting the stove to the chimney must be cleaned with a flue brush.

### **Periods of Prolonged Non-Use**

If the stove is to be left unused for a prolonged period of time then it should be given a thorough clean to remove ash and unburned fuel residues. To enable a good flow of air through the appliance to reduce condensation and subsequent damage, leave the air controls fully open.

### **Extractor fan**

There must not be an extractor fan fitted in the same room as the stove as this can cause the stove to emit smoke and fumes into the room.

### **Aerosol sprays**

Do not use an aerosol spray on or near the stove when it is alight.

### **Use of operating tools**

Always use the operating tools provided when handling parts likely to be hot when the stove is in use.

### **Chimney Fires**

If the chimney is thoroughly and regularly swept, chimney fires should not occur. However, if a chimney fire does occur turn off the stove immediately and isolate the mains electricity supply (if applicable), and tightly close the doors of the stove. This should cause the chimney fire to go out. If the chimney fire does not go out when the above action is taken then the fire brigade should be called immediately. Do not relight the stove until the chimney and flue ways have been cleaned and examined by a professional.

### **Permanent air vent**

The stove requires a permanent and adequate air supply in order for it to operate safely and efficiently. In accordance with current Building Regulations the installer may have fitted a permanent air supply vent into the room in which the stove is installed to provide combustion air. This air vent should not under any circumstances be shut off or sealed.

## **USER OPERATING INSTRUCTIONS**

### **Recommended fuels**

Stoves may be designed to burn dry seasoned wood logs and/or solid mineral fuel as indicated in the main stove manuals.

### **HETAS Ltd Approval**

HETAS approval may be limited to specific fuel types as detailed in the main instruction manuals. Approval does not cover the use of other fuels either alone or mixed with the recommended fuel, nor does it cover instructions for the use of other fuels.

## The fine heat from wood

You have purchased a wood stove. In many respects, wood used as fuel is an ideal choice. But what exactly is wood? Under the influence of sunlight, a tree builds up wood cells from CO<sub>2</sub> (carbon dioxide), water and minerals. So, in fact, wood is stored solar energy. In its growth process, the tree takes CO<sub>2</sub> from the air and gives off oxygen in return. Also in terms of the environment, wood is an ideal fuel. When it is left to rot, the same amount of CO<sub>2</sub> is released as when it is burned. In environmental terms, we then say that wood is 'CO<sub>2</sub>-neutral'.

### Only dry wood is stove wood

Not all wood qualifies as stove wood. Good burning is obtained by using wood that has been seasoned for at least eighteen months. That is to say: preferably chopped wood that, stored under a shelter and protected from the rain, can slowly let its moisture evaporate. Dry wood does not sizzle in the fire and does not soot the glass.

### The Woodstocker. Getting firewood good and dry.



Erik Bendien created the wood store that allows wind access from every side. This is logical - wind dries wood. Hence the basic grid, which is free of the ground to avoid damp, the perforated side-panels and the extra space above. The uprights and the grid are in stainless - galvanized - steel. After a while the corten-steel side panels start to oxidise. It's designed that way because the thin layer of rust is both highly decorative, and protects the panels against further corrosion. The basic module, with a single compartment, can handle 1.3 cubic meters of wood. This can be widened by the same dimensions. It looks good as a garden partition or alongside the drive. With the user-friendly instruction you can put together The WoodStocker in no time at all. The highly robust finished item can be manoeuvred when empty. And disassembling The WoodStocker is just as easy, when you move house.

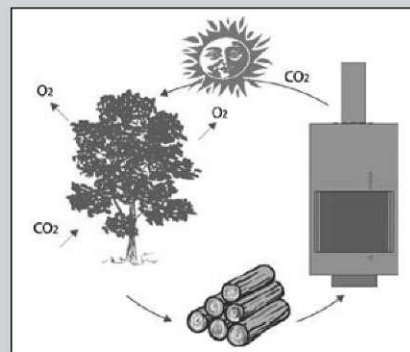

## Initial fire-up, a good start

You have purchased a brand-new stove, 'zero on the meter', has not seen a flame yet. This means you are going to take care of the initial 'miles'. The ceramic firebricks will start evaporating moisture and your wood-burning stove will start setting. For this reason, the first few times, do not make your fire too hot because otherwise the bricks could crack. You need not worry about any shrinkage cracks.

The initial fire-up requires some additional time and attention, as well as the approach we have outlined below for you in steps. Before starting, please note the following important points:

When starting the fire in the stove, open the aeration slide. (This is the kindling position.)

You can properly control the fire with the aeration slide. The further the slide is opened, the more vigorously your fire will burn.

Make sure there is sufficient ventilation.

## Initial fire-up in steps



1. Open the air slide completely by pulling it towards the front of the stove. This is the kindling position.



2. Light a large ball of dry paper against the back plate of the burning chamber and allow this fire to go out again.



3. Fill the stove with a handful of dry and thin kindling wood and light it. When it burns properly, close the air slide a bit by pushing it inwards.



Stir up the fire off and on by setting the door ajar for just a moment each time.



4. Allow the fire to burn up and the stove to cool off for an hour so that the moisture in the firebrick can evaporate. Some liquid might come free from the ceramic fire-brick. Therefore place an old towel underneath the stove before firing-up



5. After an hour, you will start bringing the entire stove to the proper temperature using first some thin kindling wood. Use the kindling position of the air slide until the fire burns properly.



6. Then use thicker logs,  $\pm$  5x5 cm thick and 20 cm long. At the same time, leave the aeration slide open. Close it a little bit when the fire is burning properly.

## How to use the Fuga eL



1. Fully open the air-control slide by moving it towards the front of the stove. This is the kindling position.



2. Place 3 fairly thick logs on the bottom of the stove. Stack some kindling wood on top of them. Stack lightly. Light the kindling wood up in the stove with a firelighter or some paper. Allow some time for the stove to heat up in order to ensure a proper draught and a good fire under the more solid logs to be added.



3. When the stove has been burning properly for a while, add a few more solid logs. (First open the aeration slide.) Stack lightly. The amount (not more than 3 logs) depends on the heat required.

4. A quietly burning fire is obtained by closing the air slide even more by pushing it inwards. This will reduce the draught in the Fuga eL. For a glowing mass of charcoal, you may close the air slide even further. The heat will then last longer. When you want to let the fire die down, you must open the air slide more.

### Preferred order of wood thicknesses to be used when you start burning the stove.



1. kindling wood ( $\pm 2 \times 2 \times 30$ cm)

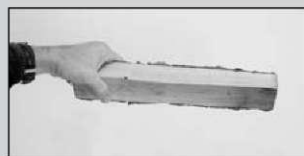

2. thicker wood ( $\pm 4 \times 4 \times 30$ cm)



3. solid log ( $\pm 7 \times 7 \times 30$ cm)

## The power of fire

As a matter of fact just a few things withstand a real hot fire. Your fireplace can also be damaged by overheating.

Just to prevent this, take account of not burning more than 3,5 kilograms of wood at the same time. 3,5 Kilograms is approximately equal to 3,5 large logs; oak with 15% moisture. The construction and the materials used from the fireplace are chosen to control and resist a fire in a considered way. So heat with consideration.

## A few tips

Make the fire always on a bed of ash. This is an insulating layer for the fire and an excellent bed for the fuel.

If the Fuga eL is overloaded with too much wood and the maximum amount of oxygen is supplied (which happens when the air slide is fully open), the fire may 'run wild'. If this should occur, close air slide by pushing it inwards. Never in such case leave the fireplace unattended.

You also control the temperature by the amount and kind of fuel used for each load.

Remove excess ashes using a shovel or an ash cleaner. Never remove ashes using a vacuum cleaner because fire may still continue to smoulder for days. Make sure you leave a layer of ashes ( $\pm 3$  cm) for the next fire to be made.

When the weather is foggy, pre-heat the flue prior to lighting your fire..

## Maintenance

### Maintenance



Dust the stove using a non-fibrous cloth.

Use the Harrie Leenders Polisher to touch up small spots and give the stove its shine back. Ask your supplier for advice.

Inox: Remove stains with a soft cloth. Use Harrie Leenders Inox-Cleaner. Note: Inox cleaner can damage the paint of the stove. Be careful.

### Maintenance ceramic firebricks

You need not worry about any cracks in the ceramic firebrick elements as long as the flame does not come into direct contact with the metal behind them.

### Glass



The glass can steam up when burning wet fuel or too little oxygen is supplied. Also, the glass may steam up if the fire does not start fiercely enough. This happens, for instance, when you start with small logs instead of thin kindling wood. Moisture will then remain in the fireplace for too long, and will settle on the coldest part: the glass.

Light moisture:

Use paper towel and then remove the light moisture using a damp cloth. Counter pressure a little at the outside so that the glass panel does not move.

Thicker deposits:

These can be treated with special fireplace- glass cleaner (this can also be done with a piece of moist paper towel and white ash). Allow a moment for this to have its effect. Always make sure that these agents do not come into contact with the painted surfaces in order to prevent stains from being formed.

### Moving parts

Moving and squeaking parts can be lubricated using graphite grease. Ask your supplier for advice.

### Collecting soot when sweeping the chimney

The refractory-board baffle and steel baffle must be removed so that the soot being removed during chimney sweeping will land at the bottom of the stove.



1. Slightly lift the ceramic baffle and pull it towards you. You can then take it out easily. Then lift the steel baffle to remove it.



2. Place a newspaper on the bottom of the stove to collect the accumulated soot. Close the door and the air-control slide.

After sweeping the chimney, remove the accumulated soot from the stove and put the refractory baffle and the steel baffle back in their respective positions.

## Installation instructions

- All local regulations including those referring to national and European standards must be observed when installing the appliance.
- Ensure there is sufficient ventilation / air supply in the room from which your stove gets the combustion air. This is the room where the stove is installed if you do not use a wall or stove-base air-supply system.
- The stove is not suitable for a shared flue system.
- Ensure adequate access for cleaning the appliance, the flue gas connection and the chimney.
- When installing the stove, take into account the minimum distances from the wall so as to avoid any fire risk. The minimum distances (sizes in cm) are shown in the figure below.

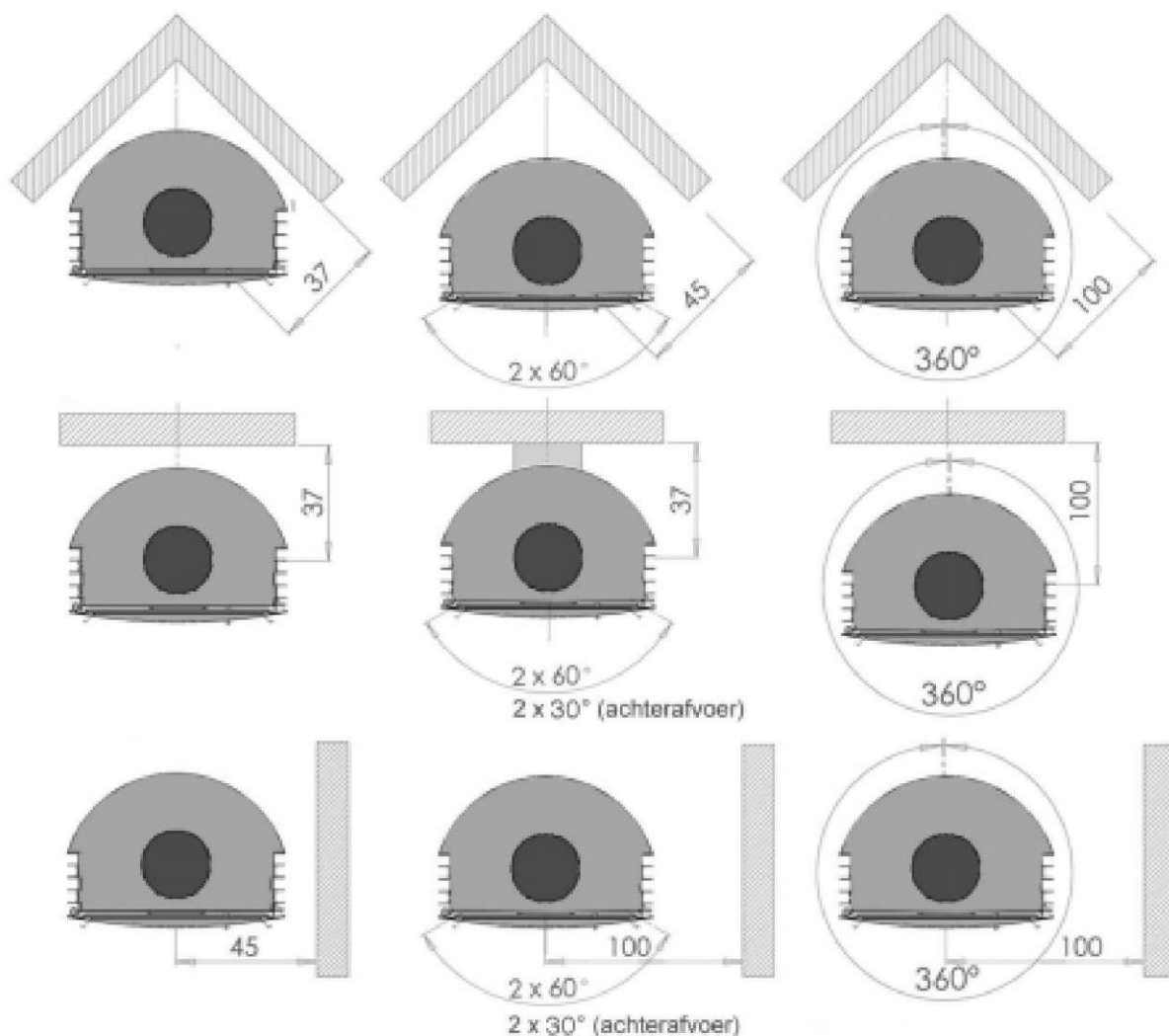

### Specifications Fuga eL

Nominal power of the stove is 8 kW.

Flue gas mass flow = 8.6 g/s

Appliance weight = 130 kg

Minimum chimney draught = 8.0 Pa

Flue gas temperature directly over the stove = 317 °C

## General instructions and regulations

The installation of the Fuga eL with decorative casing must be carried out by a skilled person employed by a dealer recognized by Harrie Leenders Haardkachels.

The casing parts are susceptible to scratching. Handle them gently.

After the stove has been properly installed, burn some kindling wood to check the draught.

Please Note, the Fuga eL has been tested by the manufacturers on a 3m straight flue.

## Safety recommendations

Glass tends to break easily, and broken glass is quite sharp. Therefore take adequate safety precautions.

For general safety, we refer to guidelines or regulations issued by a relevant official body

## Materials and tools required

Crosshead screwdriver

Flathead screwdriver

Boxspanner set

Hexagonal wrench set

## Materials included

4 S6 plugs

4 stucco screws

Set of masonry bits Knife

Plumb line Sliding pieces

4 self-tapping screws 0 3.5 x 9.5 (+2 spares)

Spirit level Handtruck

Single-walled pipe and accessories (connector)



### 1. Moving the stove

Remove the door and put it in a safe place  
Place styrofoam or a packing cushion between the stove and the handtruck for protection.  
Move the stove with its front resting against the handtruck.  
Remove the plastic wrapping after positioning the stove.



### 2. Installing wall plate for stove with rear outlet

Determine the centre of the wall plate at 114 cm above the floor.  
Fix the wall plate with connection ring using plugs and chipboard screws.  
Fill up gap, if any, between wall and wall plate if necessary in order to ensure the wall plate is plumb.  
Mark off the centre of the stove on the floor (standard distance from wall is 37 cm).



### 3. Positioning the stove

Push the stove in the marked position using the sliding pieces. Be careful not to damage the floor.  
Remove the sliding pieces.  
Remove the packaging.

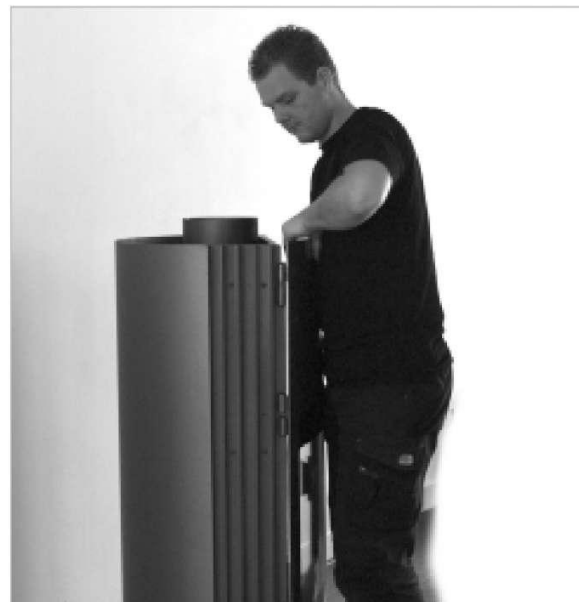

### 4. Replace the door

Carefully hang the door back on it's hinges.  
Be careful not to cause any damage.



#### 5. Rotatable base

Fixed position: leave the stove as delivered.  
2x30° (rear outlet) or 2x60° (top outlet) rotatable: slacken bolt no. 2. Slightly loosen bolts no. 1 and secure them with the nut  
Check to ensure bolts no. 1 have not been loosened too much.  
360° rotatable (possible for top-connected stove pipe only): remove all bolts.



#### 6. Levelling

Tilt the stove to gain access to the four adjusting feet.  
Turn the adjusting feet to level the stove.  
Make sure that all of the adjusting feet touch the floor in order to ensure the stove's stability.  
Push the edge rubber down to avoid leaving a slit.



#### 7. Air supply

When using an external air supply : leave the cover strip in place.  
If there is no external air supply: remove the cover strip from the base (crosshead screwdriver).

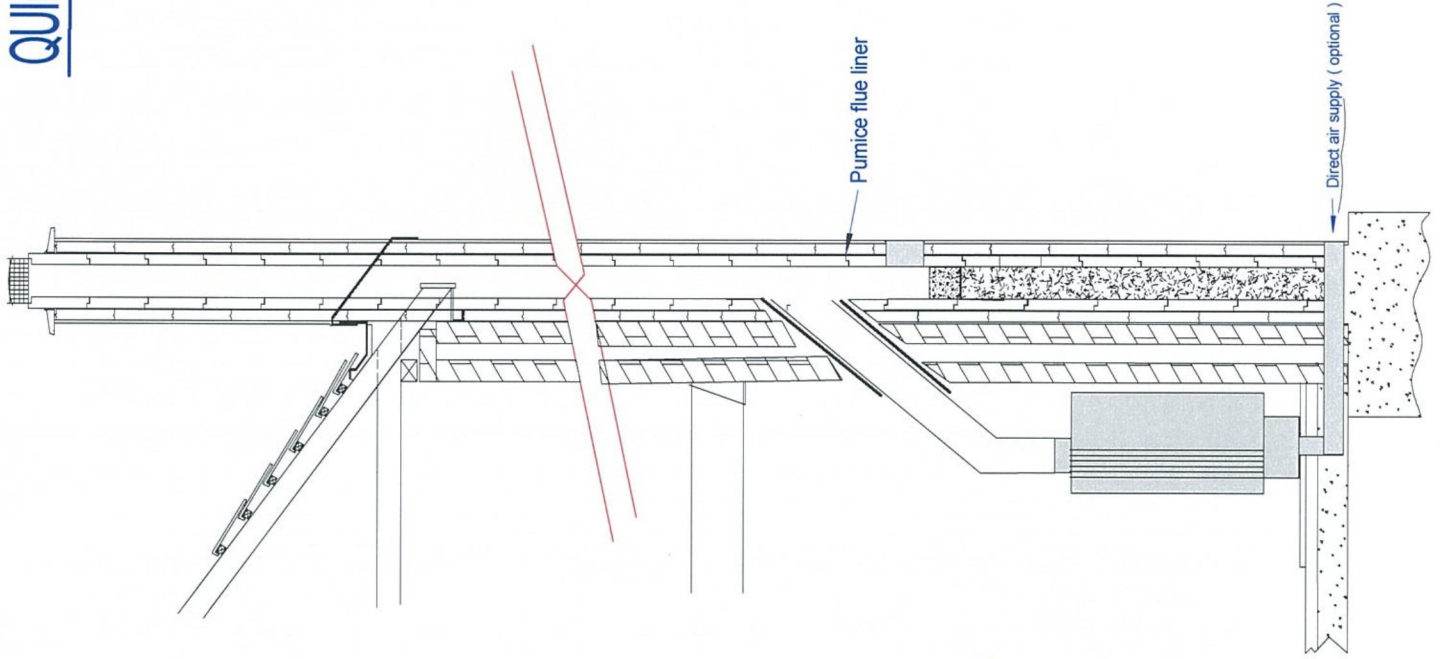

**TYPICAL INSTALLATION**

For guidance purposes only, this is NOT a working drawing.  
Please ensure that all appliance and flue installations are undertaken by a competent approved installer, following the Harrie Leenders installation guide and are to current local Building Regulations.  
We recommend that all dimensions are checked against the appliance on site.  
The wall behind the appliance / flue pipe should be protected or be heat resistant ( e.g. tile or brick ).

**QUICK GUIDE - FUGA**

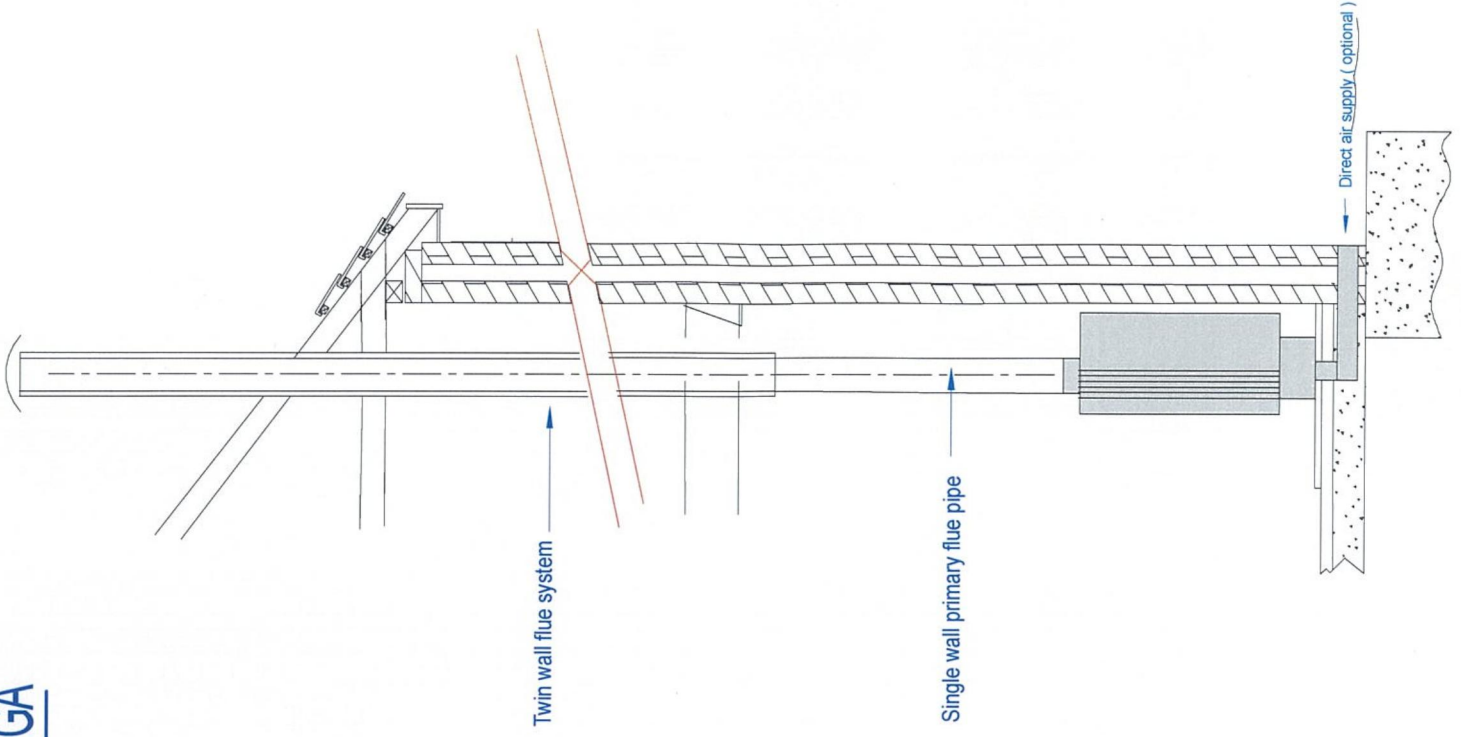



Harrie Leenders Haardkachels  
Industrieweg 25, 5688 DP Oirschot, The Netherlands  
Tel. +31 (0)499 572710, Fax +31 (0)499 573714  
info@leenders.nl



Robeys

U K Distributor.

Robeys Ltd.  
Riverside, Goods Road, Belper,  
Derbyshire, England. DE56 1UU  
Tel: 01773 820940 Fax: 01773 820477  
E Mail: info@robeys.co.uk  
www.robeys.co.uk

  
**Harrie Leenders**

[www.leenders.nl](http://www.leenders.nl)

June 2011